



User Manual



Each Energy Technology (Suzhou) Co., Ltd.

Address: No.8 Building, No. 38 of Beiguandu Road, Yuexi Street, Wuzhong District, Suzhou, Jiangsu Province, China

Tel: +8651266581088

Email: service@eachenergy.com

Web: www.eachenergy.com

Each Energy Technology (Suzhou) Co., Ltd.

www.eachenergy.com

Without written permission, any information of this document (partly or entirely) cannot be extracted, copied or transmitted in any form or by any means. All right reserved.

Notice:

The information in this document is subject to change without notice. Please adhere to the actual products in case of any discrepancy. Any statements, description, and recommendations in this manual do not constitute a guarantee or warranty of any kind, explicitly or implicitly.

Warranty:

Warranty terms and conditions can be downloaded from the Internet at www.eachenergy.com.

8. Specification

Model	PHS3K-M1	PHS3.6K-M1	PHS4K-M1	PHS4.6K-M1	PHS5K-M1	PHS6K-M1	PHS8K-M1
Battery/Input Data							
Battery type	Li-Ion						
Battery voltage range	80V-500V						
Max. Charging/discharging current	60A/60A						
Rated charging/ discharging current	50A/50A						
Charging strategy for Li-Ion battery	Self-adaption to BMS						
Communications	RS485, CAN						
PV String DC Input Data							
Recommended max. PV power	4.8KW	5.8KW	6.4KW	7.4KW	8KW	9.6KW	12.8KW
Max. input voltage	600V						
Start-up voltage/Min. input DC operation voltage	40 V/30 V						
MPPT voltage range	80V - 580V						
Max. input current	18A/36A						
Max. short circuit current	22A/44A						
MPPT number	2						
Strings number per MPPT	1/2						
AC Output Data(On-Grid Side)							
Rated output power	3KW	3.6KW	4KW	4.6KW	5KW	6KW	8KW
Rated /Max. apparent output power	3KVA/3KVA	3.6KVA/3.6KVA	4KVA/4KVA	4.6KVA/4.6KVA	5KVA/5KVA	6KVA/6KVA	8KVA/8KVA
Rated grid output current	13.0A	15.7A	17.4A	20A	21.7A	26.1	34.8
Max. output current	13.0A	15.7A	17.4A	20A	21.7A	26.1	34.8
Operation phase	1P						
Rated grid voltage/range (L/N/PE)	220V/230V/240V / 180 - 300 V						
Rated grid frequency	50Hz/60Hz						
Power Factor	>0.99 (0.8 leading ~ 0.8 lagging)						
THDi	<3%						
AC Output Data(Back-Up/UPS Side)							
Rated output power	3KW	3.6KW	4KW	4.6KW	5KW	6KW	8KW
Peak apparent output power, for 60S	6KW	7.2KW	8KW	8KW	8KW	9KW	9.6KW
Back-Up/UPS switch time	<10 ms						
Rated grid voltage/range (L/N/PE)	220V/230V/240V / 180 - 300 V						
Rated frequency	50Hz/60Hz						
Rated output current	13.0A	15.7A	17.4A	20A	21.7A	26.1	34.8
THDv (@linear load)	<2%						
AC Input Data(Grid Side)							
Rated grid voltage/range (L/N/PE)	220V/230V/240V / 180 - 300 V						
Rated grid input current	13.0A	15.7A	17.4A	20A	21.7A	26.1	34.8
Max. input current	13.0A	15.7A	17.4A	20A	21.7A	26.1	34.8
Operation phase	1P						
Rated grid frequency	50Hz/60Hz						
Diesel Generator Data							
Operation phase	1P						
Rated grid voltage/range (L/N/PE)	220V/230V/240V / 180 - 300 V						
Rated grid frequency	50Hz/60Hz						
Efficiency							
Max. efficiency	98.60%						
EU efficiency	98.10%						
Protection							
Ground fault monitoring	Yes						
Output over voltage protection	Yes						
Anti-islanding protection	Yes						
Integrated AFCI	Optional						
DC reverse-polarity protection	Yes						
AC short circuit protection	Yes						
Leakage current protection	Yes						
Surge protection	Yes						
DC switch (solar)	Yes						
Battery input reverse polarity protection	Yes						
Over voltage category	AC ClassIII/PV ClassII						
General Data							
Dimensions (W*H*D)	411*401*166 mm						
Shell material	Aluminium alloy						
Weight	15.7 Kg						
Operating ambient temperature range	-25~60 °C(45 °C derating)						
Topology	Transformerless						
Ingress protection	IP66						
Cooling concept	Natural Convection						
Max. operation altitude	3000 m						
Grid connection standard	AS/NZS 4777.2:2020, EN50548-1:2019, G99:2021, NC RFG, PTP/REE, ABNT NBR 16149, ABNT NBR 16150, VDE-AR-N 4105, CEI0-21, RD1699						
Safety/EMC standard	IEC-62109-1/-2, IEC-62477-1/-2, IEC-61000-6-1/-2/-3, NBT32004						
DC connection	MC4/D4						
Communications	Wifi, 4G, GPRS, Bluetooth, RS485, CAN						

38	Battery Volt is Low	The battery voltage is too low	1. Increase the battery quantity in series 2. Contact the installer
39	Battery Curr Hard High	The hardware current of battery is too high	1. Decrease the battery quantity in parallel 2. Contact the installer
40	Battery Temperature is High	The battery temperature is too high	1. Check the ventilation of batteries 2. Check the installation area, if inappropriate, change the installation place 3. Contact the installer
41	Battery Temperature is Low	The battery temperature is too low	1. Check the installation area, if inappropriate, change the installation place 2. Check if the ambient temperature exceeds the operation temperature of the battery 3. Contact the installer



NOTE

If any event in the above table is displayed, please turn off the inverter, wait 5 minutes and then restart the inverter.

Contents

1. About the Manual	3
2. Product Overview	4
3. Safety	7
4. Mounting	8
4.1 Installation Location	8
4.2 Inverter Mounting	10
5. Electrical Connection	11
5.1 DC Side Connection of Inverters	11
5.2 Battery Side Connection of Inverters	13
5.3 AC Side Connection of Inverters	13
5.4 External Grounding Connection	15
5.5 Communications Connection	15
5.6 Earth Fault Alarm	17
5.7 Over Current Protection Device	18
5.8 Electrical Connection Overview	18
5.9 Meter and CT Installation (optional)	18
5.10 Residual Current Device (RCD)	20
5.11 DRM (Demand Response Mode)	20
5.12 Remote Disconnection and Reconnection	21
6. Operation	21
6.1 Start and Stop Inverters	21
6.2 LCD Operation	22
6.2.1 Main Menu	22
6.2.2 Basic Info	23
6.2.3 Basic Setup	25
6.2.4 Detail Info - Maintenance Personnel Only	26
6.2.5 Technical Set – Maintenance Personnel Only	31
7. Maintenance and Troubleshooting	46
8. Specification	54

1. About the Manual

The manual describes product information, mounting, installation, operation, maintenance, troubleshooting and specification of Each Energy inverters.

Validity

The document is valid for the following inverter models: PHS3K-M1, PHS3.6K-M1, PHS4K-M1, PHS4.6K-M1, PHS5K-M1, PHS6K-M1, and PHS8K-M1

Target Group

The target group of this manual are end users and qualified persons who have knowledge of inverters or skills of inverter installation, maintenance, etc. Only qualified persons are allowed to perform the installation and activities marked in this document under the guidance of safety instructions. Please read this manual carefully before conducting any kind of work on the inverters.

Valid Region

This manual applies to the operation of Each Energy inverters in Australia, New Zealand, the UK, EU, South America, North America, and Southeast Asia.

			limit if permitted
32	PEN No Connect	Grounding fault as the PE and N line has not been connected well	1. Check the connection of the PE line and the N line 2. Contact the installer
33	Back Up Volt Out Range	The voltage of backup is out of permissible range	1. The voltage of the backup load is beyond the acceptable range, please decrease the power of the backup load; 2. Contact the installer
34	Back Up Over Load	The power of backup load is too large	1. The power of the backup load is too large, please decrease the backup load; 2. Contact the installer
35	CAN Loss	No CAN signal has been connected by the inverter	1. Please check the connection of battery communications line 2. Contact the installer
36	Battery is not connected	The battery has not been connected to the inverter	1. Check the Connection of batteries; 2. Contact the installer
37	Battery Volt is Over	The battery voltage is too high	1. Decrease the battery quantity in series 2. Contact the installer

26	Grid Volt Over 110%	The grid is overloaded by 10% for over 10 minute	<ol style="list-style-type: none"> 1. Wait for the inverter to recovery 2. If the impedance of AC cable is too small, replace it with a larger size cable 3. Adjust the protection value limit as permitted by the grid company
27	Grid Volt Out Range	Grid voltage is out of range	<ol style="list-style-type: none"> 1. If the impedance of AC cable is too small, replace it with a larger size cable 2. Adjust the protection value limit as permitted by the grid company
28	Grid Freq Out Range	Grid frequency is out of range	Adjust the protection value limit through self-designing function as permitted by the grid company
29	Relay Fault	Fault in grid-connection relay	Restart the inverter or contact the installer
30	MS Comm Fault	Communication fault between the main CPU and the slave CPU	Restart the inverter or contact the installer
31	Power to Grid beyond Limit	Power exported to Grid exceeds the Hardware Limit	<ol style="list-style-type: none"> 1. Turn on the software limit and set up a software limit that is lower than the hardware limit 2. Turn off the hardware

2. Product Overview

2.1 Product Description

Each Energy PHS3K-M1, PHS3.6K-M1, PHS4K-M1, PHS4.6K-M1, PHS5K-M1, PHS6K-M1, and PHS8K-M1 single phase hybrid inverters convert DC power generated by photovoltaic panel arrays into AC power, supply power to household load, store power into a battery and feed extra power into utility grid.

Product Appearance:

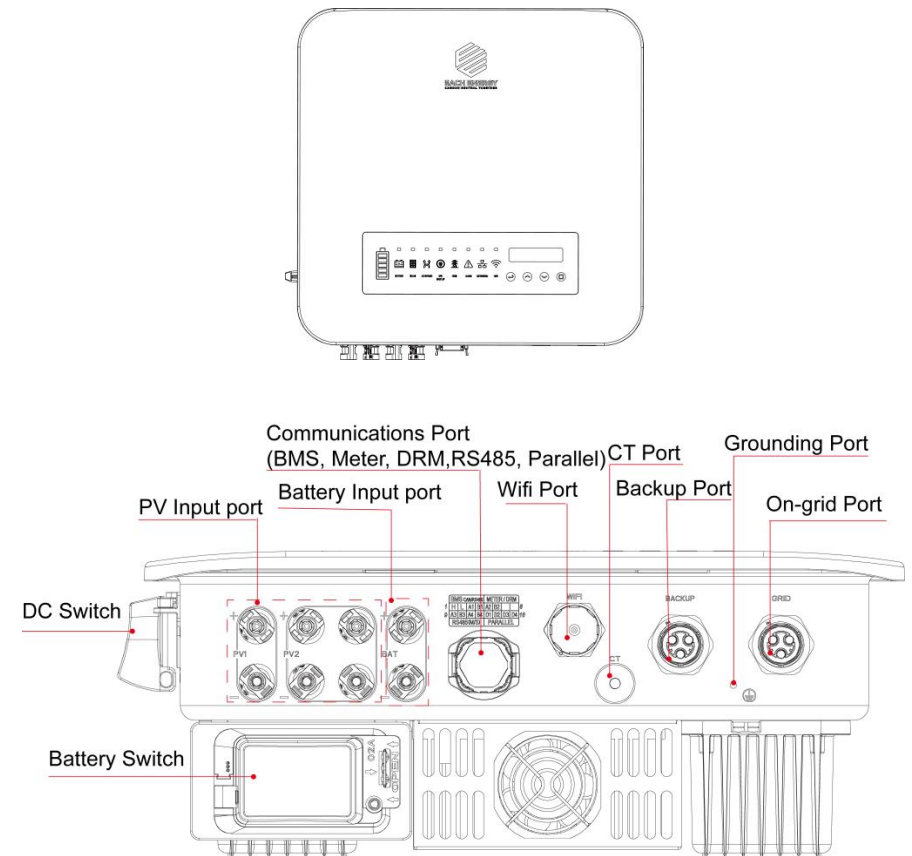

2.2 Front Panel

Operation Panel:

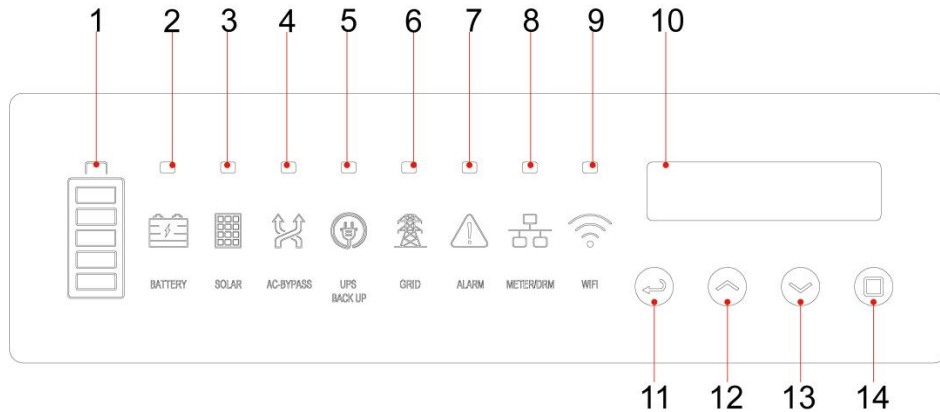

No.	name	Status	Explanation
1	Battery Indicator	On	Indicate the battery's state of charge
		Flash	The battery is being charged
2	Battery	On	A battery has been connected
		Off	No battery is connected
3	Solar	On	Solar panels have been connected
		Off	No solar panel is connected
4	AC bypass	On	The backup load is powered by the Grid
		Off	The backup load is powered by PV or battery
5	Backup	On	Backup power is available
		Off	Backup power is not available
6	Grid	On	The inverter is connected to the Grid
		Off	The inverter is not connected to the Grid
7	Alarm	On	A alarm or warning is detected
		Off	No alarm or warning is detected
8	Meter/DRM	On	A meter or DRED has been connected
		Off	No meter or DRED has been connected

20	DCI Out Range	DC component is too large	Restart the inverter or contact the installer
21	ISO Out Range	The insulation impedance is too small	<ol style="list-style-type: none"> 1. Remove all DC inputs, reconnect them one by one, and restart the inverter 2. Identify the string that causes the fault and check the insulation of the string
22	No Grid... Pls Turn On AC	No utility grid	<ol style="list-style-type: none"> 1. Check the AC breaker 2. Check the connection of AC plug 3. Check whether the inverter's L, N, PE line have been connect with the corresponding grid L, N, E line correctly
23	Temp is Too High	Temperature is too high	<ol style="list-style-type: none"> 1. Check the ventilation of installation environment 2. Avoid direct sunlight
24	Temp is Too Low	Temperature is too low	Check if the ambient temperature is below normal working temperature of inverters and increase ambient temperature
25	PV Over Voltage	Over voltage in PV Inputs	<ol style="list-style-type: none"> 1. Check if the input voltage exceeds the inverter's upper limit of input voltage. 2. Decrease solar panel quantity in series

12	Extern Flash	Abnormality in external flash reading and writing	Restart the inverter
13	Bus Unbalance	Bus Unbalance	Restart the inverter
14	Low bus voltage	Low bus voltage	1. Check if the input voltage is too low 2. If not, restart the inverter 3. If yes, increase solar panel quantity in series
15	Over Frequency	Export reduction due to over frequency	Adjust the protection value limit by user-designing function as permitted by grid company
16	Over Temperature	Export reduction due to over temperature	1. Check the ventilation of installation environment 2. Avoid direct sunlight
17	GFCI Device Fault	Fault in current leakage testing device	Restart the inverter or contact the installer
18	ACHCT Device Fault	Fault in HCT device on AC side	Restart inverter or contact the installer
19	GFCI Out Range	Current leakage is out of range	Check the AC connection and DC connection, and check internal wire connection

9	WiFi	On	The inverter has connected to a Wifi network
		Off	The inverter has not connected to a Wifi network
10	LCD		It is to show the basic info or setup info
11	Return		The Key to return to previous page
12	Up		The Key to go Up
13	Down		The Key to go Down
14	Enter		The Key to confirm

2.3 Scope of Delivery



Inverter * 1



Wall bracket * 1



Expansion Screws * 4



Fastening Screws * 3



PV Connectors * 3



AC Connectors * 2



Communications Connector * 1









WiFi Data logger * 1



Documents * 1

3. Safety

3.1 Safety Symbols

Symbol	Explanation
 DANGER	Indicates a high level of risk which, if not avoid, may result in death or serious injury
 WARNING	Indicates a medium level of risk which, if not avoid, may result in death or serious injury
 CAUTION	Indicates a low level of risk which, if not avoid, may result in minor or moderate injury
 NOTE	Indicates a situation which, if not avoided, may result in device damage or property damage
 ELECTRIC SHOCK	Indicates a danger of electric shock or high voltage
 HOT SURFACE	Indicates hot surface, do not touch
 WAIT	Notice of waiting at least 5 minutes before operation

3.2 Safety Instructions and Notice for Use

The inverters involved in this manual comply with applicable safety and technical regulations in design and test. To avoid personal injury and property damage and to ensure longer service life of the machines, please read this manual carefully and observe all safety information during operation.

Improper operation may result in risk of person injury or damage to the machine and to other property, so please ensure that the following requirements are met before or during operation.

- Installation of inverters must be performed by qualified technicians, and be in compliance with applicable electrical standards, regulations and the

5	Bus Over Voltage Hard	Transient bus voltage exceeds the hardware protection limit	1. Check if the input voltage exceeds the inverter's upper limit of input voltage 2. If not, restart the inverter 3. If yes, decrease solar panel quantity in series
6	Transient Over Voltage	Transient over voltage in grid	Restart the inverters
7	Inv Over Current Soft	Inverter software over current	1. Restart inverters 2. Decrease string in parallel
8	Inv Over Current Hard	Inverter hardware over current	1. Restart inverters 2. Decrease string in parallel
9	Island Protect	Island effect protection	1. Check whether AC circuit breaker has been triggered off 2. Check AC cables connection 3. Check whether grid is not in service 4. If the above reasons have been excluded and this fault still occurs in the LCD screen, contact the installer
10	Low Temperature Inside Inverters	Low Temperature Inside Inverters	Check if the ambient temperature is below normal working temperature of inverters and increase ambient temperature
11	High Temperature Inside Inverters	High temperature inside inverters	1. Check the ventilation of installation environment 2. Avoid direct sunlight

7.3 Storage and Transportation

If the inverters will not be installed in a short term, please store them in a dry room with the ambient temperature between -25~60 °C . For storage and transportation, please pack them in the original package if possible and stack inverters no more than 8 packs.

7.4 Troubleshooting

No.	Events	Explanation	Solutions
1	DC Volt Over	High voltage of PV input strings	1. Check if the input voltage exceeds the inverter's upper limit of input voltage 2. Decrease solar panels quantity in series
2	DC Over Current Soft	PV current exceeds the software protection limit	1. Restart the inverter 2. Decrease solar panels quantity in parallel if it occurs repeatedly
3	DC Over Current Hard	PV current exceeds the hardware protection limit	1. Restart the inverter 2. Decrease solar panels quantity in parallel if it occurs repeatedly
4	Bus Over Voltage Soft	Transient bus voltage exceeds the software protection limit	1. Check if the input voltage exceeds the inverter's upper limit of input voltage 2. If not, restart the inverter 3. If yes, decrease solar panel quantity in series

requirements of local power authorities.

- Wear protective equipment for all work on the machines: helmet, insulated footwear, gloves, etc.
- Ensure that unauthorized persons and children have no access to the machines.
- Do not open the housing of the machines at any time. Unauthorized opening will void guarantee and warranty and may damage the machines.
- Do not touch non-insulated parts or cables, disconnect the machines from voltage sources and guarantee no possible re-connection before working on the machine.
- Use measuring devices with a DC input voltage range of 600 V or higher only.
- High voltage is present in the live parts and cables inside the product during operation, wait at least 5 minutes after disconnecting voltage sources.
- The temperature of some parts of the inverter may exceed 60 °C during operation. To avoid being burnt, do not touch the inverter during operation.
- Pack inverters properly during transportation, and do not transport them together with flammable material.
- The battery compatible with the inverter shall be approved by the inverter manufacturer. The compatible battery list can be obtained through the official website.
- Back-up function is not recommended if the PV Inverter is not connected with batteries.

4. Mounting

4.1 Installation Location



WARNING

Do not select locations storing flammable material which may cause fire or explosion!

The following points should be considered when selecting an installation location.

- The wall bearing inverters shall be able to hold the weight of at least 4 times of the weight of the inverters.
- The location shall be convenient for electrical connection, operation and maintenance.
- The ingress protection of the inverter is IP66, so it can be installed both indoors and outdoors.
- The temperature of the cooling fin may exceed 75 °C, so select safe locations.
- The location must be well ventilated and sheltered from direct sunlight, rain or snow.
- Ensure the visibility of the LED lights and LCD display on the front panel of inverters.
- Install inverters vertically or with a backward tilt within 15 degrees. No lateral tilt is allowed.
- If more than one inverter are installed in one location, a minimum 150 mm clearance should be kept between two inverters and a minimum 300 mm clearance between inverters and the ground.

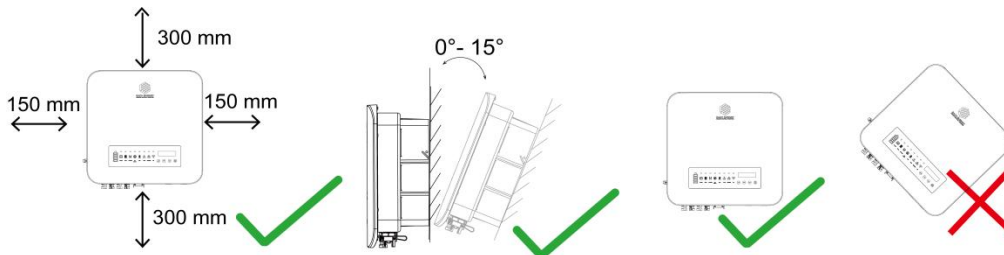

- The Inverter is to be installed in a high traffic area where the fault is likely

6.2.5.17 Strategy Mode

1. Auto Mode

When select this mode, the time of battery charging, discharging and energy allocation mode of inverter will be the default one.

->Auto Mode

2. Table Mode

When select this mode, the time of battery charging, discharging and energy allocation mode of inverter will can be set up by users.

->Table Mode

7. Maintenance and Troubleshooting

7.1 General Maintenance

The Inverters do not need regular maintenance and just ensure that they are free of dust, foliage and other dirt.



NOTE: The use of cleaning agents may damage the machine and its components. Only use a cloth moistened with clear water to clean the machine.

7.2 Disposing of Inverters

If the inverters need to be disposed of, please do that according to the local regulations for electrical equipment waste, and choose the right site for the disposing specified for electrical equipment waste according to local regulations.

4	->Active Batt	To activate the battery
5	->Grid Start	Reserved
6	->Grid A	To set up the grid charging current
7	->Grid Charge	To set up the grid charging mode
8	->Grid Signal	Reserved
9	->Gen Start	The SOC that the generator starts to charge the battery automatically
10	->Gen A	The current that the generator starts to charge the battery automatically
11	->Gen Charge	To select the generator to charge
12	->Gen Signal	The signal of the generator
13	->Gen Force	The connection of generator compulsorily
14	->Restart	The lowest value that the battery restarts

to be seen.

4.2 Inverter Mounting

Dimension of the mounting bracket:

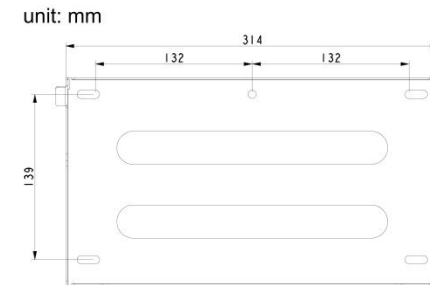

Procedures:

- 1) Ensure that the bracket is horizontal. Mark the position of the drill holes. For brick walls, the position of the holes should suit expansion screws.
- 2) Use a 10 mm drill bit to drill mounting holes of 40 mm deep.
- 3) Insert the expansion tubes into holes.
- 4) Screw the expansion screws into expansion tubes with a cross screwdriver to fix the bracket on the wall.

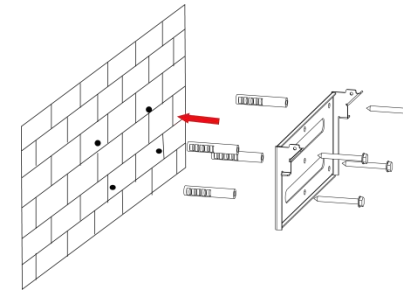

- 5) Lift up the inverter, and hang it on the mounting bracket securely.
- 6) Lock the inverter to the mounting bracket with screws.

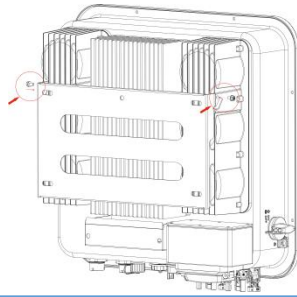

NOTE: To protect your hands from scratch, please wear gloves!

5. Electrical Connection

5.1 DC Side Connection of Inverters

This inverters are compatible with monocrystalline silicon, polycrystalline silicon, and thin-film PV panels.



NOTE: The inverter cannot be used with functionally earthed PV Arrays.



DANGER ELECTRICAL SHOCK

Lethal high voltage will be generated by PV arrays under sunlight, so please disconnect DC and AC breakers and ensure no possibility of re-connection before conduct electrical connection!

PV strings should be connected to the inverter through special PV connectors that are in the scope of delivery.

Press UP/DOWN to scroll the menu, press ENT to perform the selection, and press ESC to return to the previous menu.

6.2.5.15 Export Limit

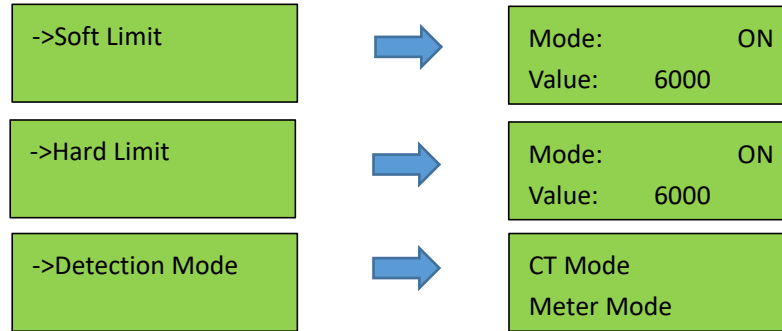

The inverter's export limit can be achieved together with external devices such as a CT or meter. There are two types of limit, soft limit and hard limit. The soft limit means that the limit is controlled by software, and hard limit means that if the generation exceeds the limit, the inverter will stop working. Under the detection mode menu, you can choose CT mode or meter mode. For the normal working of inverters, please use the soft limit only. The hard limit is used only by compulsory requirement of local grid companies.

6.2.5.16 Battery Set

No.	LCD Display	Explanation
1	->BMS Agreement	To set up the BMS Agreement
2	->Max charge	To set up the max charge current
3	->Max Discharge	To set up the max discharge current

6.2.5.10 Password Set-up

The password for 'Detail Info' and 'Technical Set' can be reset here.

Password:	1000
Confirm:	1000

Press ENT to move the cursor, press UP/DOWN to select a number for a digit selected, and press ENT to confirm the setup after the last digit has been set up. Press ESC to return to previous menu.

6.2.5.11 Factory Reset

This function is designed to restore factory defaults.

YES=ENT	EXIT=ESC
Are You Sure ?	

6.2.5.12 Adjust Total E

The total energy generated may be cleared or changed after maintenance or translocation, and the previous data can be restored with this function. The total energy generated can be adjusted here.

TOTAL	ENERGY
5700000 KWh	

6.2.5.13 Reset Total E

The total energy generated record can be cleared here, and after clearing, the energy generation record will be zero.

YES=ENT	EXIT=ESC
Are You Sure?	

Press ENT to clear the energy generation history and press ESC to cancel the previous operation.

6.2.5.14 Export On/Off

This function is to control the grid connection or disconnection of inverters.

Inverter	ON/OFF
ON	



NOTE: Use only the supplied connector or the connector with IP 65 or above to guarantee that the protection ingress of the whole inverter is IP66!

It is recommended to use the DC cable of 4 mm²



NOTE: Use DC cables specialized for photovoltaic systems Only!

Assemble DC cables to DC connectors:

- 1) Strip the insulation layer off the DC Cable for a little length.
- 2) Insert the wire into the Crimp Contact and crimp them with an electrical crimp-er.

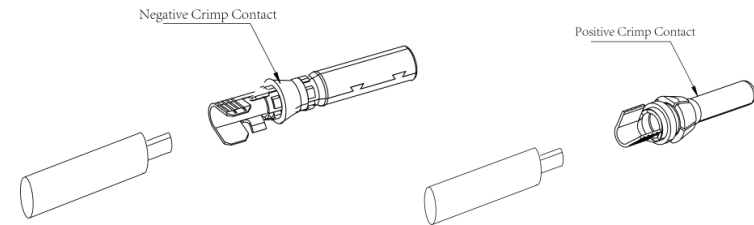

- 3) Thread the cable through the Cable Gland, insert it into the insulator, and gently pull backward the cable to ensure firm connection. Then screw up the Cable Gland to the Insulator.

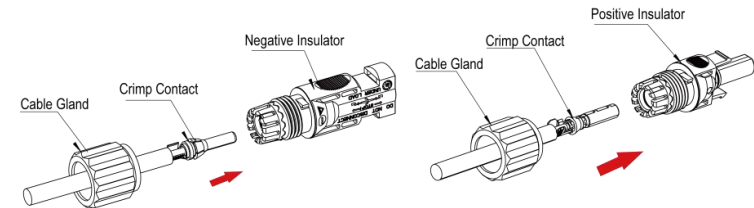

Install the DC connectors to the Inverter:

- 1) Turn the Grid Supply Main Switch OFF.
- 2) Turn the DC switch OFF.

3) Connect the DC connectors to the Inverter, small click confirms connection. Please guarantee the correct polarity of the connection.



WARNING

Ensure that the open circuit voltage of PV array is within the max. input voltage of the inverter!



WARNING: Do not turn off DC switch directly for accident reverse connection of DC inputs or any fault of inverters as it may damage inverters. In that case, turn off the DC switch only when the DC current is below 0.5 A.

5.2 Battery Side Connection of Inverters

Please assemble battery cable to battery connectors in the same way as that of PV side connection as described in 5.1.



DANGER

Please disconnect upstream and downstream power source when connect battery to inverter.



DANGER

Please ensure that the open circuit voltage of the battery is within the permissible input range of the inverter.

5.3 AC Side Connection of Inverters

There are two AC ports, namely Backup AC port and Grid AC port. The same AC connectors, which are supplied together with the inverter, can be used for the two ports and the connection are also the same.

status to 'ON' or 'OFF'.



NOTE: This operation is for maintenance personnel only. Password is required to access this part!

6.2.5.9.4 Fixed Power Factor Mode or the Reactive Power Mode

PF CURVE

OFF

Q CURVE

OFF

Those modes are disabled by default. The fixed power factor mode or the reactive power mode may be enabled in some situations by the electrical distributor to meet local grid requirements, one of these modes shall be enabled if the volt-var mode is disabled.

Procedures to set up the Reactive Power Mode:

Step1: go to 'All Set Enable' in the menu of 'TECHNICAL SET' and turn the status to 'ON'.

Step2: go to 'Special Func', then go to 'Q Curve' and enable the Q Curve by change the status to 'ON'

Step3: go to 'Power Control' and then go to 'Q Set'.

Step 4: Set up the Reactive Power Mode manually.

Procedures to set up the Fixed Power Factor Mode:

Step1: go to 'All Set Enable' in the menu of 'TECHNICAL SET' and turn the status to 'ON'.

Step2: go to 'Special Func', then go to 'PF Curve' and enable the PF Curve by change the status to 'ON'

Step3: go to 'Power Control' and then go to 'PF Set'.

Step 4: Set up the Fixed Power Factor manually.



NOTE: This operation is for maintenance personnel only. Password is required to access this part!

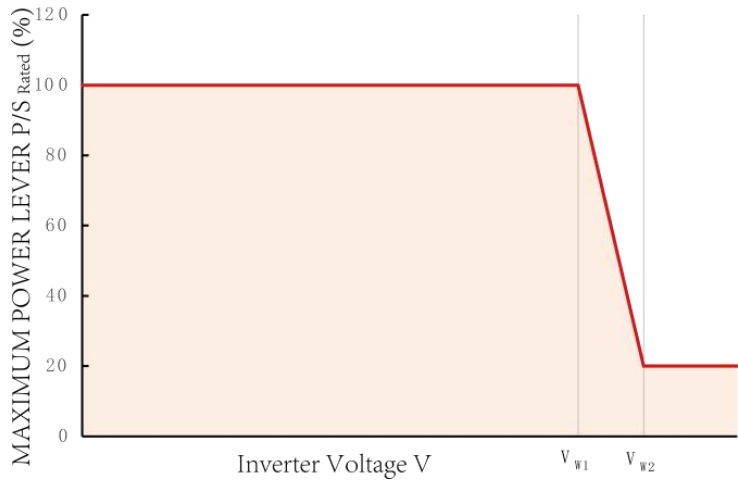

Region	Default Value	V_{w1}	V_{w2}
Australia A	Voltage	253 V	260 V
	Inverter maximum active power output level (P)% of S_{rated}	100%	20%
Australia B	Voltage	250 V	260 V
	Inverter maximum active power output level (P)% of S_{rated}	100%	20%
Australia C	Voltage	253 V	260 V
	Inverter maximum active power output level (P)% of S_{rated}	100%	20%
New Zealand	Voltage	242 V	250 V
	Inverter maximum active power output level (P)% of S_{rated}	100%	20%

Procedures to enable or disable the Volt-watt Response Mode:

Step1: go to 'All Set Enable' in the menu of 'TECHNICAL SET' and turn the status to 'ON'.

Step2: go to 'Special Func' and then go to 'PU Curve'

Step3: enable or disable the 'Volt-watt Response Mode' by changing the

For the sake of safety, please use 4 – 6 mm² outdoor cable.

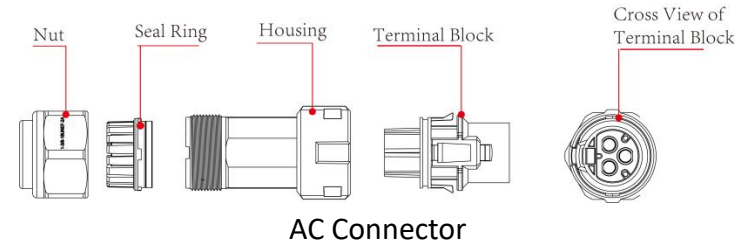

Procedures:

1) Strip the insulation layer off the AC cable about 8 to 15 mm.

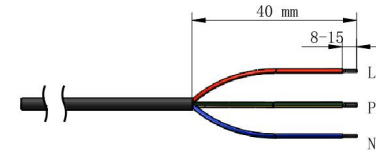

2) Thread the AC cable through the Nut and the Housing.

3) Connect wires to the Terminal Block:

insert yellow green wire to the grounding (PE) terminal, red or brown to live line (L) terminal and blue or black to zero line (N) terminal; screw up screws on the connectors with socket head wrench and pull back wires to ensure firm connection.

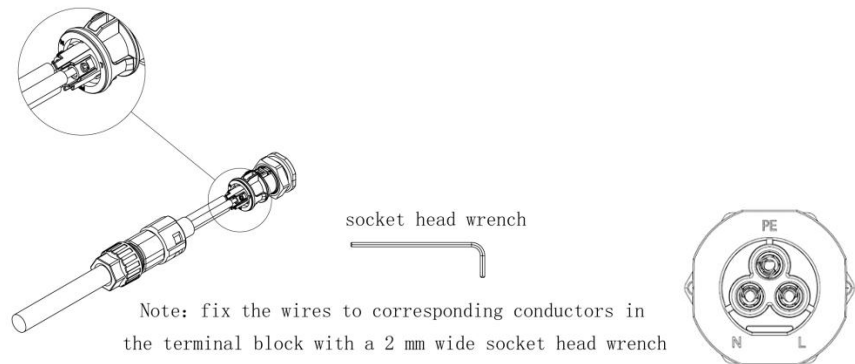

4) Connect the Nut, Seal Ring, Housing and Terminal Block together, a small

click confirms secure connection.

- 5) Connect the AC connector to the inverter, a small click confirms connection.

5.4 External Grounding Connection

The external grounding port is located beside the AC connection terminal of the inverter.

Procedures:

Prepare an OT terminal M4, crimp a grounding cable to the terminal, insert a fastening screw into the OT terminal, insert them to the grounding port on the inverter, and screw them tightly.

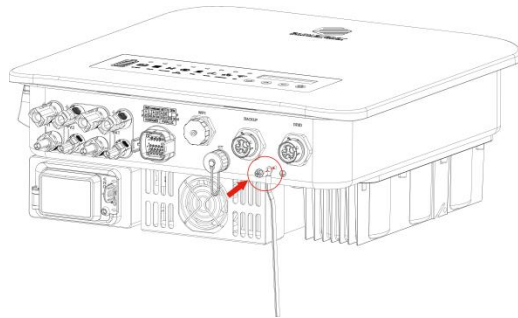

WARNING: The external grounding connection cannot replace the connection of PE terminal in AC connection. Ensure that both the external grounding connection and the PE connection are done properly!

5.5 Communication Connection

5.5.1 WiFi Communications Connection

WiFi Data logger Installation

Assemble WiFi data logger to the corresponding port on inverter as shown in the diagram.

	Inverter reactive power level (Q)% of S_{rated}	44% supplying	0%	0%	60% absorbing
New Zealand	Voltage	207 V	220 V	235 V	244 V
	Inverter reactive power level (Q)% of S_{rated}	60% supplying	0%	0%	60% absorbing

Procedures to enable or disable the Volt-var Response Mode:

Step1: go to 'All Set Enable' in the menu of 'TECHNICAL SET' and turn the status to 'ON'.

Step2: go to 'Special Func' and then go to 'QU Curve'

Step3: enable or disable the 'Volt-var Response Mode' by changing the status to 'ON' or 'OFF'.



NOTE: This operation is for maintenance personnel only. Password is required to access this part!

6.2.5.9.3 Volt-watt Response Mode

PU CURVE ON

The PU Curve is enabled by default. The volt-watt response mode varies the maximum active power output level of the inverter in response to the voltage at its grid-interactive port. The diagram below is the response curve required for the volt-watt response according to the standard of AS/NZS 4777.2:2020.

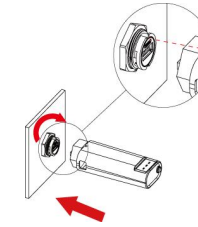
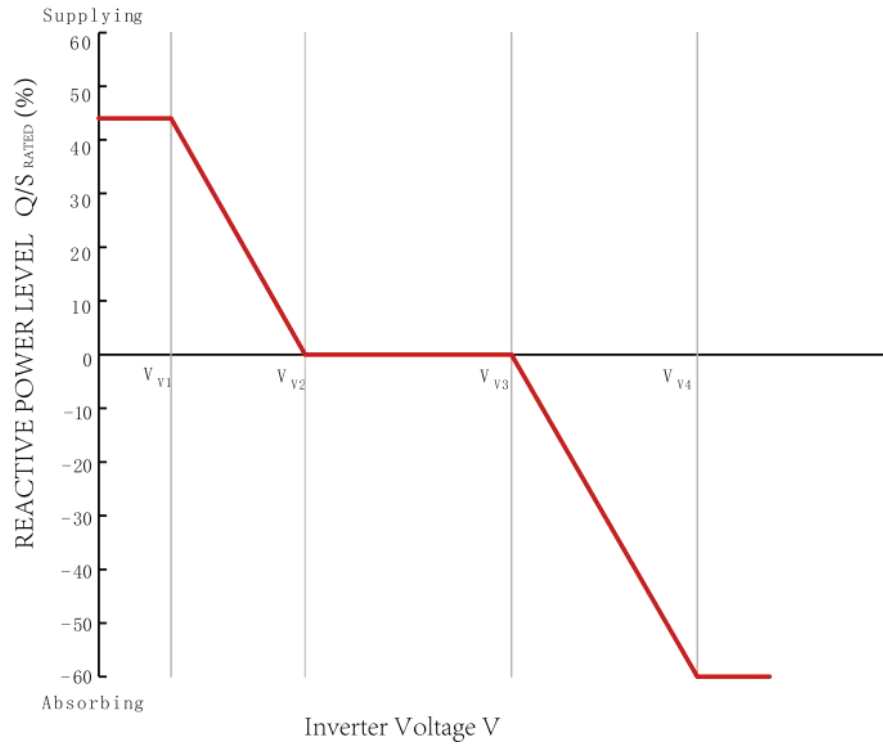

- 1) Plug the logger to the Wifi port on the inverter
 - 2) Rotate the front operative part of the stick clockwise till the secure connection of the stick
- More detailed information about communications can be found in corresponding manuals.

5.4.2 Communications of BMS, Meter, DRM, Inverters Parallel, and RS485

5.5.2 Battery Communications :

The communications between the inverter and battery BMS, meters & DRM, RS485 and parallel inverters is explained below.

Connector Assemble Procedures:

- 1) Strip the insulation layer off the communications cable for a little length.
- 2) Insert the wire into the Crimp Contact and crimp them with an electrical crimp-er.

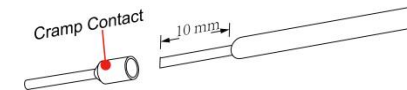

- 3) Thread the communications cable through Nut, Seal Ring, and Housing successively, and insert the cable into the corresponding pin of the Terminal (Function of corresponding pin will be introduced below).

Region	Default Value	V_{V1}	V_{V2}	V_{V3}	V_{V4}
Australia A	Voltage	207 V	220 V	240 V	258 V
	Inverter reactive power level (Q)% of S_{rated}	44% supplying	0%	0%	60% absorbing
Australia B	Voltage	205 V	220 V	235 V	255 V
	Inverter reactive power level (Q)% of S_{rated}	30% supplying	0%	0%	40% absorbing
Australia C	Voltage	215 V	230 V	240 V	255 V

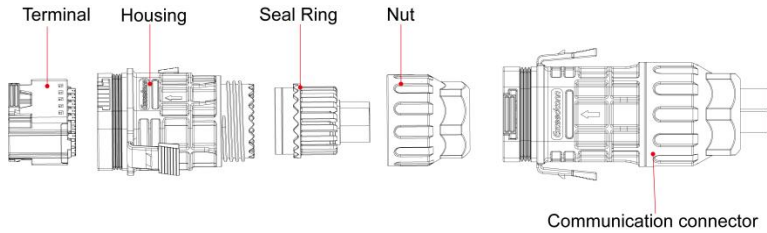

- 4) Connect the the Nut, Seal Ring, Housing and Terminal together.
- 5) Plug the connector to the Communication port of the inverter.

Functions of pins of the communications connector:

There are 16 pins of the connector, please insert wire into the right pin for the intended function.

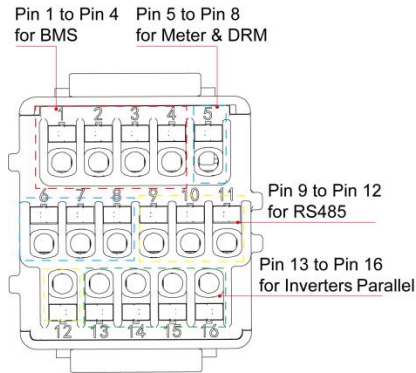

5.6 Earth Fault Alarm

The inverters are designed with an earth fault alarm function. If an earth fault occurs, the inverters will stop generating power, the red alarm light will be on and the LCD will display 'ISO Out Range' or 'PEN No Connect'. In that case, please refers to Chapter 7 for troubleshooting or contact Each Energy for help.

12	QU CURVE	To enable the QU curve
13	PF CURVE	To enable the PF curve
14	Q CURVE	To enable the Q curve
15	PU CURVE	To enable the PU curve
16	Shadow MPPT:	To enable the shadow MPPT mode

6.2.5.9.1 Island Protection

The active anti-islanding protection of the inverters is achieved by shifting the frequency of the inverter away from nominal conditions in the absence of a reference frequency (frequency shift). It is enabled by default.

6.2.5.9.2 Volt-var Response Mode

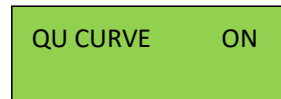

The QU Curve is enabled by default. The volt-var response mode changes the reactive power absorbed or supplied by the inverter in response to the voltage at its grid-interactive port. The diagram and table below are the response mode required for the volt-var response according to the standard of AS/NZS 4777.2:2020.

6.2.5.9 Special Function Setup

No.	LCD Display	Explanation
1	Set CV MPPT	To set up the constant PV voltage
2	All PV Paral	To set up the multiple MPPTs parallel mode
3	HVRT	To enable the High Voltage Ride Through
4	LVRT	To enable the Low Voltage Ride Through
6	DCI Prot	To enable the DC component inspection
7	GFCI Prot	To enable the GFCI protection
8	ISO Prot	To enable the ISO protection
9	Island Prot	To enable the island protection
10	Buzzer Enabled	To enable the buzzer
11	Relay Check	To enable the relay

5.7 Over Current Protection Device

It is recommended to install a breaker (over current protection device (OCPD)) to protect the AC grid connection conductors. The table below is the recommended parameter of an OCPD ratings for the Inverter.

5.8 Electrical Connection Overview

The following is a diagram of a typical solar system for your reference to install inverters.

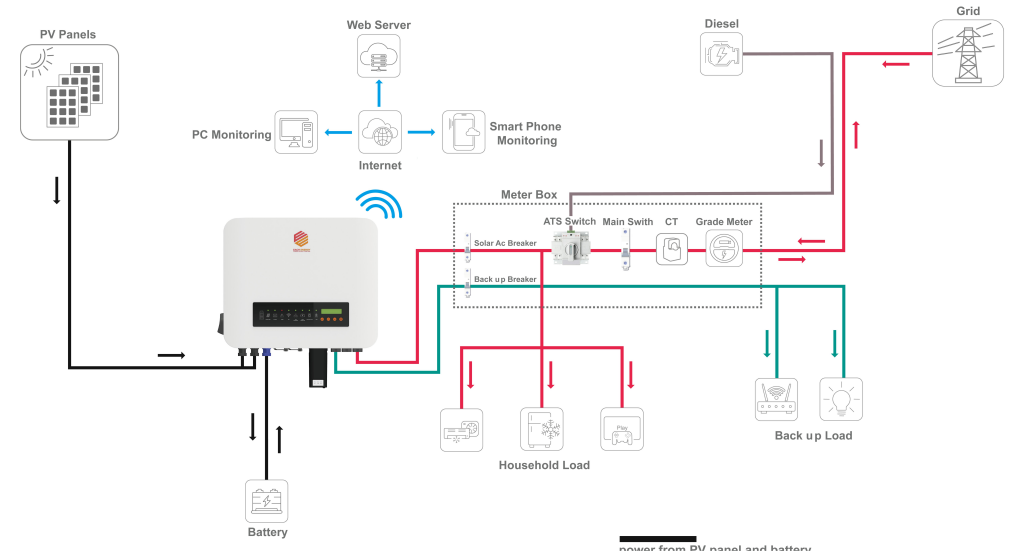

5.9 Meter and CT Installation (optional)

A meter and CT(current transformer) can be connect to corresponding ports on inverter to monitor electricity parameter such as current, voltage, power, etc. and to realize export power management.

The suggested parameter:

Max input current for meter: 120A
 Max measuring current for CT: 100A

Detail specifications of meter and CT can be found on Each Energy Website and a customer can purchase a suitable meter and CT for inverters on the website.



NOTE

No need to change any parameter of the meter as it has been preset in the factory!

Meter and CT connection:

For more information about meter and CT connection, please refer to corresponding manuals on Each Energy website. The following is schematic diagrams for reference.

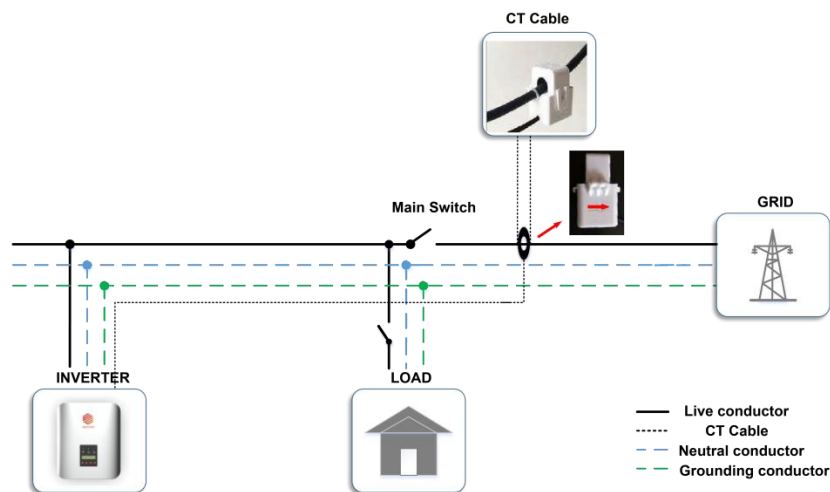

CT Installation Electrical Diagrams



DANGER ELECTRICAL SHOCK

Turn off upstream and downstream electrical connection before the meter installation!

4	PR Reset	To restore power factor
	YES=ENT EXIT=ESC Are You Sure ?	

Reactive power and power factor can be set up and restored here. The power quality response modes as required by the standard of AS/NZS 4777.2:2020 can be activated or controlled under this menu combined with the menu of special function. The detail procedure will be described in the following part.

6.2.5.8 Standard Function

Power increase slope and decrease slope can be set up here.

Pwr UpSlope	Pwr DownSlope
90%	20%

This part is for the setup of power rate limit modes as required by AS/NZS 4777.2:2020. Soft ramp up after connect, reconnect or soft ramp up/down following a response to frequency disturbance is available in those inverters.

Procedures to set up the gradient of power rate limit:

Step1: Go to 'All Set Enable' in the menu of 'TECHNICAL SET' and turn the status to 'ON'.

Step2: Go to 'Standard Func' and then get inside.

Step3: Go to set up the 'Pwr UpSlope' or 'Pwr DownSlope' for the soft ramp up/down of rated power per minute.



NOTE: This operation is for maintenance personnel only. Password is required to access this part!

VAC H Limit Set
270V

VAC L Limit Set
180V

The detailed procedure is described in a separated document named 'Voltage Adjustment'.

6.2.5.5 Max Generation Power Setup

The max output power can be set up here.

Pmax Limit
70% of Prated

The detailed procedure to set up the Max generation power is described in a separated document named 'Power Generation Limit'.

6.2.5.6 AC Instant Voltage Limit

The rated AC Instant Voltage Limit can be set up here.

AC Inst Limit 500V

6.2.5.7 Power Control

No.	LCD Display	Explanation
1	Q Set +60%	To set up reactive power
2	PF Set +80%	To set up power factor
3	Q Reset	To restore reactive power
	YES=ENT EXIT=ESC Are You Sure?	

5.10 Residual Current Device (RCD)

An internal residual current device is integrated in the inverter to protect against any potential residual current. If the residual current that exceeds a set limit is detected, the inverter will stop working, the warning light will be on and the LCD will display 'GFCI Device Fault' or 'GFCI Out Range'.

If you need to install an external RCD as required by local grid company, we suggest a Type-A RCD with a threshold current higher than 100 mA.

5.11 DRM (Demand Response Mode)

The DRM port is only applicable to installations in Australia and New Zealand as requires by the standard of AS/NZS 4777.2:2020. The inverter detects and initiates a response to the demand response modes listed in the following table.

Mode	Functions
DRM 0	Operate the disconnection device
DRM 5	Do not generate power
DRM 6	Do not generate at more than 50 % of rated power
DRM 7	Do not generate at more than 75 % of rated power AND absorb reactive power if capable
DRM 8	Increase power generation (subject to constraints from other active DRMs)

Ways to connect a DRED (demand response enabling device) to inverters

- 1) Assemble a RJ45 connector by connecting a network cable to the RJ45 according to the international conventional method;
- 2) Plug the RJ45 connector to the DRM port of the inverter.

Power rate limit modes as required by AS/NZS 4777.2:2020 is supported in this inverters. When a demand response mode (except for DRM 0) is asserted or unasserted the power rate limit will apply to the increase or decrease in power generation or consumption and the transitions between power levels.

When a DRED is connected to an inverter, the inverter will receive and response to the outside signal directly. And the DRM working mode will be shown in the BASIC INFO in the LCD menu.

5.12 Remote Disconnection and Re-connection

The Inverters are designed with the function of remote disconnection and re-connection. To use this function, a Wi-Fi or 4G data logger stick has to be fixed to the Wifi port and work properly. The pin 2 and pin 3 of the data logger stick are allocated for this function. Then the remote disconnection and reconnection can be achieved by sending instruments through the monitoring App Solarman Business.

6. Operation

6.1 Start and Stop Inverters

6.1.1 Inverter Turning-on

The following procedures have to be followed exactly to start an inverter.

- 1) Turn on the AC breaker.
- 2) Turn on the DC Switch.
- 3) After a compulsory delay of 30 to 300 seconds, the inverter will start to work and the POWER light will be on.



WARNING

Ensure that the open circuit voltage of PV array is within the max. input voltage of the inverter!

6.2.5.2 Standards Set

The safety standard for different countries can be selected in this sub-menu.

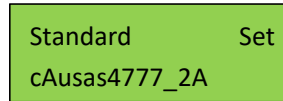

Australia A, Australia B, Australia C and New Zealand grid codes can be selected here. cAUSAS4777_2A, cAUSAS4777_2B, cAUSAS4777_2C and cNZS4777_2 represent Australia A, Australia B, Australia C and New Zealand standard respectively.

Procedures:

Step1: go to 'All Set Enable' in the menu of 'TECHNICAL SET' and turn the status to 'ON'.

Step2: move to 'Standard Set' and get inside

Step3: select the country grid code needed.

Press UP/DOWN to scroll through the national standards, press ENT to confirm the safety standard, and press ESC to return to the previous menu.



NOTE: This operation is for maintenance personnel only. Password is required to access this part!

6.2.5.3 Rated AC Voltage Set

The rated AC voltage can be set up here.

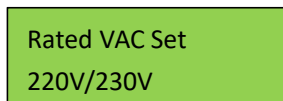

6.2.5.4 AC Output Voltage Limit

This section is to set up the high and low limit of AC output voltage as permitted by local grid company if the grid voltage is beyond the range specified by national standards.

14	Factory Reset	To restore factory settings
15	Adjust Total E	To adjust the total power generated
16	Reset Total E	To clear the power generation record
17	Export ON/OFF	To turn on/turn off grid export function
18	Export Limit	To set up export power limit
19	Battery Set	The set up functions regarding battery charging and discharging
20	Strategy Mode	The strategy for energy management

Press UP/DOWN to scroll the menu, press ENT to access the sub-menu, and press ESC to return to the previous menu.



NOTE: This part is accessible for qualified and accredited technicians only!

6.2.5.1 All Set Enable

This function is to enable all the setting-up functions under the menu of 'Technical Set'. Before enabling or setting up any of the function under this menu, please turn the 'All Set Enable' on.

ALL SET Enable
ON



DANGER ELECTRIC SHOCK

High voltage may present, please beware of the risk of electric shock and take protection precautions!

6.1.2 Inverter Turning-off

The following procedures have to be followed exactly when stop an inverter.

- 1) Switch off the AC Switch.
- 2) Wait around 30 seconds for the capacitor to dissipate energy. Then turn the DC switch OFF.
- 3) Be sure that all LED light is OFF (around 1 minute).



CAUTION WAIT

Beware of the risk of electrical shock! Wait at least 5 minutes before touching the machine although the DC switch has been turn off!

6.2 LCD Operation

6.2.1 Main Menu

When the inverter has been started, the LCD screen shows operation status and power of the inverter alternately every 10 seconds (refer to below figure). You can press UP and DOWN keys to scroll the screens and press ENTER key to access the main menu. The main menu includes four sub-menus: BASIC INFO, BASIC SETUP, DETAIL INFO, and TECHNICAL SET.

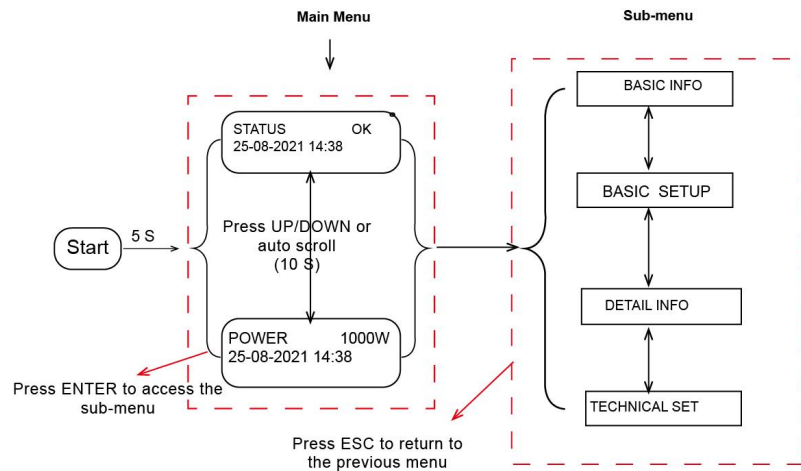

6.2.2 Basic Info.

The table below explains the meaning of information displayed in the sub-menu of Basic Info.

No.	Displays	Duration	Explanation
1	TOTAL ENERGY 50000 Kwh	10 S	Total energy: total energy generated
2	ThisMon: 255Kwh LastMon: 254Kwh	10 S	This Month: total energy generated this month Last Month: total energy generated last month
3	TODAY: 52 Kwh PRE_DAY : 54Kwh	10 S	This Day: total energy generated today Previous Day: total energy generated yesterday

2	Standard Set	To set up safety standard or country grid code for the inverters
3	Rated VAC Set	To set up rated AC out voltage
4	VAC H Limit	To set up the high limit of AC output voltage
7	VAC L Limit	To set up the low limit of AC output voltage
8	Pmax Limit	To set up the max generation power
9	AC Inst Limit	To set up the AC instant voltage limit
10	Power Control	To set up the power control
11	Standard Func	To set up the increase power rate limit and decrease power rate limit
12	Special Func	To set up special functions
13	Set Passwords	To set up passwords

6.2.4.12 BAT Info.

No.	Display	Explanation
1	Batt Capacity 400Ah	The capacity of battery module
2	Shutdown 10%	The shutdown threshold value of Battery SOC
3	Low Batt 20%	The threshold value of low battery value
4	Batt Module Num 4	The number of battery number
5	Batt Cell Num 10	The number of cell in each battery module

6.2.5 Technical Set – Maintenance Personnel Only

This section is for maintenance personnel only, enter password to access the sub-menu as guided by Chapter 6.2.4.

The sub-menu:

No.	Display	Explanation
1	ALL Set Enable	To enable the setting-up of all functions under the menu of Technical Set

4	DC VOL1: 401.5V DC CUR1: 18.6A	10 S	DC voltage1: the DC voltage of the PV input 1 DC current1: the DC current of the PV input 1
5	DC VOL2: 408.5V DC CUR2: 18.6A	10 S	DC voltage2: the DC voltage of the PV input 2 DC current2: the DC current of the PV input 2
6	DC VOL3: 408.5V DC CUR3: 18.6A	10 S	DC voltage3: the DC voltage of the PV input 3 DC current3: the DC current of the PV input 3
7	AC VOL: 230.6V AC CUR: 38.8A	10 S	AC voltage: the voltage of the utility grid AC current: the current of the utility grid
8	FREQ: 50.2Hz POWER : 1000 W	10 S	Frequency: the frequency of the utility grid Output Power: 1000 W
9	BAT SOC: 80% BAT TEMP: 45°C	10 S	The SOC of battery: 80% The temperature of battery: 45°C
10	BAT VOL: 50.50V BAT CUR: +58.02A	10 S	The voltage of battery: 50.50V The current of battery: +58.02A
11	BAT POWER: +5800 W	10 S	The power of battery: +5800W
12	BATTERY STATUS CHARGE	10 S	The status of battery CHARGE

13	TOTAL RUNTIME: 152 H	10 S	Cumulative energy generation time
14	INVERTER SN EE00S005000001A1	10 S	Inverter SN: The SN of the Inverter EE00T005000001A1
15	MODEL:Volt-Watt DRM : DRM5	10 S	Working Mode: DRM(Demand response mode) Number:

6.2.3 BASIC SETUP

You can set time and address in this sub-menu.

No.	Display	Explanation
1	SET TIME	To set up time
2	SET RS485 ADDR	To set up RS485 address
3	SET LANGUAGE	To set up language

6.2.3.1 Time Setting-up

When the sub-menu of 'SET TIME' is selected, the LCD will display the screen as below.

NEXT = ENT OK = ESC
25-01-2022 18:23

Press ENT to move the cursor from left to right, Press UP/DOWN to select a number for a selected digit. Press ESC to save the setting and return to the main menu.

6.2.4.6 Rated Power

The rated power of the inverter is displayed here.

Rated Power
5KW

6.2.4.7 Rated Voltage

The rated voltage of the inverter is displayed here.

Rated Voltage
220V

6.2.4.8 Daily Energy

The energy generated for a specified day can be checked here.

Select Day
2020-02-22

6.2.4.8 Monthly Energy

The energy generated for a specified month can be checked here.

Select Month
2020-02-22

6.2.4.9 Yearly Energy

The energy generated for a specified year can be checked here.

Select Year
2020-02-22

6.2.4.10 Export Total

Total energy exported to grid can be checked here.

Export Total
500KWh

6.2.4.11 Export Today

The energy exported to grid today can be checked here.

Export Today
500KWh

UP/DOWN to scroll the screen to view.



NOTE: This operation is for maintenance personnel only. Password is required to access this part! Please reset the password at the first operation.

6.2.4.2 Fault Info.

When a fault happens, the Alarm Light will be on, and the LCD will display a brief description of the fault. Please refer to Chapter 7 for troubleshooting or contact after-sales department if a fault info. is displayed.

ACHCT Device
Fault

6.2.4.3 Flash Version

The Flash version of the inverter is displayed here.

Flash Version
ES 3.0

6.2.4.4 Warning Info.

If a adverse condition presents in the inverter, the LCD will display a warning information. The inverter will work normally with such warning conditions. When a warning info. is displayed, please refer to Chapter 7 for troubleshooting.

Warning Info
0x00000400

6.2.4.5 Software Version/Firmware Version

The software version or firmware version of the inverter is displayed and is accessible for technicians only.

SW Version
V01.05

6.2.3.2 Address Setting-up

The inverter RS 485 address communicating with a monitoring platform can be set here, the address ranges from '01' to '99', and the default address is '01'.

YES = ENT EXIT = ESC
Slave Add: 01

Press UP/DOWN to scroll through numbers for a selected digit, press ENT to save the setting and return to the main menu, and press ESC to return to the main menu without saving the setting.

6.2.3.3 Language Setting-up

Working language of the inverter can be set here, and the default language is English.

6.2.4 Detail Info - Maintenance Personnel Only

Select 'Detail Info' from the main menu and the LCD screen will display the following information:

NEXT = ENT EXIT = ESC
Password: 0000

Steps to view the menu of the Detail Info.:

1) Enter the password:

The default password is 1000. When finishing password entering, press ENT to verify the password. If the password is correct, the sub-menu will be displayed, and if wrong, the LCD will display 'Wrong Password' and return to the previous menu. Press ESC to return to the main menu.

2) Access the sub-menu:

After enter the correct password, the sub-menus will be displayed:

1. Operation Info, 2. Fault Info, 3. Flash Version, 4. Warning Info, 5. SW

Version, 6. Rated Power, 7. Rated Voltage, 8. Daily Energy, 9. Monthly Energy, 10. Yearly Energy, 11. Export Total, 12. Export Today, 13. BAT Info.

Press UP/DOWN to scroll the screen, press ENT to go into the selected sub-menu and press ESC to return to the main menu.

6.2.4.1 Operation Information

This information is for maintenance personnel to get the operation information, and the information is as below:

No.	Display	Duration	Explanation
1	Standard Causas4777_2A	10 S	The present safety standard
2	GFCI RMS: 10 mA ISO : 1.25 kΩ	10 S	This menu indicates: GFCI RMS: Leakage current protection ISO: Ground fault protection/Insulation Resistance
3	Heatsink Temp 65.5 °C	10 S	This menu indicates: The temperature of heat sink of inverters
4	Inv Inner Temp 45.0 °C	10 S	This menu indicates: Inverter inner temperature
5	BusVol: 385.5V DCI : 0 mA	10 S	This menu indicates: Bus voltage AC direct component

6	DCI B: DCI C:	10 S	DC component of phase B: 0 mA DC component of phase C: 0 mA
7	PF:+1.00 ac Pac Limit: 80%	10 S	This menu indicates: Power factor ratio Output power limit
8	RCD(GFCI): ON PVISOGuard: ON	10 S	This menu indicates: Residual current protection Insulation Resistance/Ground fault protection
9	AllPVParal: ON MPPTShadow:	10 S	This menu indicates: All PV in parallel mode MPPT shadow mode
10	RelayCheck:OFF DCI Prot : ON	10 S	This menu indicates: Self examination of AC relay Output direct component protection
11	Apparent Power 2000 VA	10 S	This menu indicates the apparent power
12	Active Power 2000 W	10 S	This menu indicates the active power
13	Reactive Power 2000 Var	10 S	This menu indicates the reactive power
14	Export Power 4800W	10 S	This menu indicates the power exported to grid

The operation info of inverter and part of protection info. can be view after password has been input and all the info. is included in the above table. Press